

LIVING DISTRICT

Collection:Layne

Installation manual for:









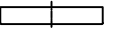

LD722D30C D30" H23.3" L6

Installation instructions:

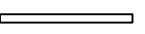
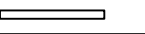
1. Black wire from ceiling(junction box) attaches to "L"wire from the fixture.
2. White wire from ceiling(junction box) attaches to "N"wire from the fixture.
3. "E" wire from the fixture is attaced to the mounting bracket and an additional "E" wire from the mounting bracket must be secured to the junction box.
4. Secure mounting bracket to the junction box.
5. Insert the mounting bracket screw(P2) into the mounting bracket (P1).
6. Twist rod(P8) to wire box(P9), Assemble other 3 rods, connect Universal head(P5) with the rod(P6).
7. Separate and adjust the lamp arms,use the screw(P3) to lock the lamp body to the mounting bracket (P1) on the ceiling.
8. Install E12 light source.(Bulbs not supplied)

The end!

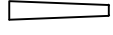
PARTS LIST

Part Number	Part	Picture	Description	Qty
CP7R01C	P1		mounting bracket Φ4.53"*H0.59"	1
	P2		Mounting bracket screw	2
	P3		Screw	2
	P4		Canopy Φ4.72"*H0.98"	1
	P5		Universal head Φ0.59"*H2.24"	1
ROD3013C	P6		Rod (L16"*Φ0.5")	1
	P7		Rod (L12"*Φ0.5")	2
	P8		Rod (L6"*Φ0.5")	1
P-LD722D30C-1	P9		Wire Box Φ3.1"*H1.4"	1
	P10		Lamp arm L22.3"	6
	P11		Socket rings	6
	P12		E12 holder	6
	P13		UL18#, L56"	1

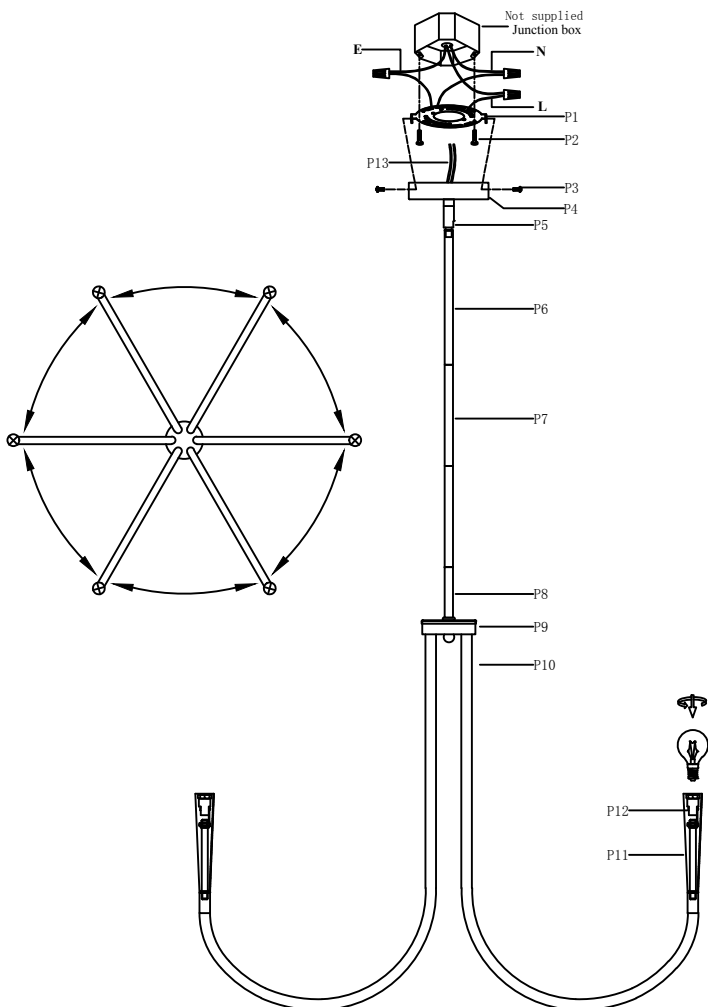

"L" = Hot wire
 "N" = Neutral wire
 "E" = Ground wire